

Section 2

Wall Guards, Wall Strips & Bed Head Protectors

Information on protection products designed to offer impact protection against damage caused by wheeled and pedestrian traffic. Includes PVC-u, stainless steel and rubber profiles.

Wall Guards & Wall Strips

Wall guards and wall strips are designed to offer impact protection against damage caused from both pedestrian and wheeled traffic, such as trolleys, wheelchairs, hospital beds, carts and other mobile equipment.

They help reduce maintenance costs and improve the overall aesthetics of a building and are ideal for use in a wide range of environments including education, healthcare, commercial, retail, hospitality and leisure environments.

Product Options

Gradus offers a wide range of wall guards that can be used individually to combat specific types and levels of damage or can be combined for a more comprehensive protection system.

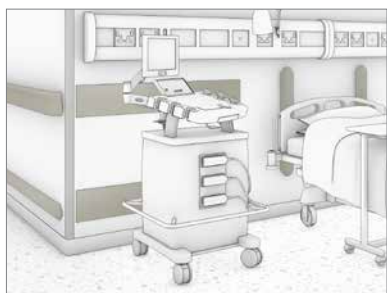

PVC-u Modular Wall Guards & Bed Head Protectors

- Modular in construction. Covers and accessories are replaceable and are through coloured and textured to conceal the effects of impact and abrasion
- Suitable for use in busy working environments such as hospital circulation areas, wards and corridors to protect against damage from pedestrian and wheeled traffic



Wall Strips

- Cost effective alternative to wall guards to protect against damage
- Designed to protect against rubs and scuffs in areas such as waiting rooms, accommodation, classrooms and canteens which is typically caused by chairs, tables and other movable objects



Rubber Wall Guards

- Robust protection against damage caused by wheeled traffic such as trolleys and carts
- Ideal for use in both interior and exterior environments such as manufacturing, warehousing, loading bays and service corridors



Stainless Steel Wall Guards

- Modern, high-tech finish to enhance interior designs
- Hygienic nature of the profiles makes them ideal for use in environments such as healthcare, food and pharmaceutical preparation and manufacturing facilities

Selecting the correct wall guard

The type and number of wall guards required will be determined by two aspects:

1. The application and environment
2. The level and type of traffic

The damage occurring on walls can vary dramatically from scuffs, scratches and scrapes caused by pedestrian traffic through to gouges and holes caused by heavier, wheeled traffic.

Example Applications

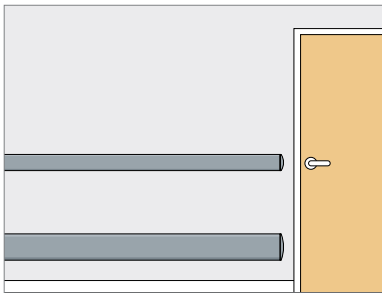

Twin PVC-u Wall Guards
Multi-level direct impact protection
Top: WGS125 - Bottom: WGS200

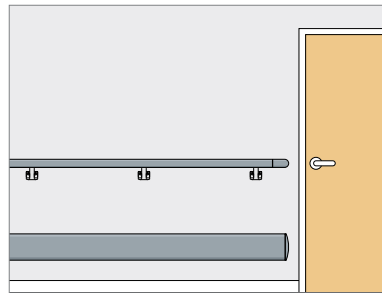

Single WGS200 PVC-u Wall Guard
Localised impact protection
shown with SHR40P Handrail

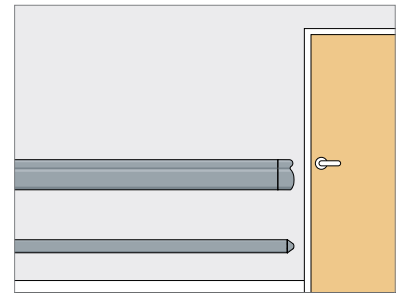

Single WGA100 PVC-u Wall Guard
Indirect impact protection
shown with CHR160 Combination Rail

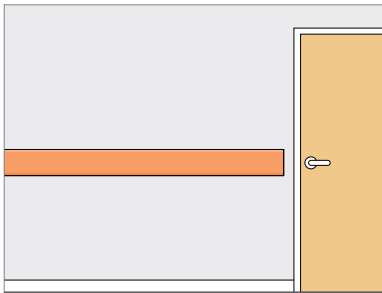

Single WST200 Wall Strip
Protects against rubs and scuffs

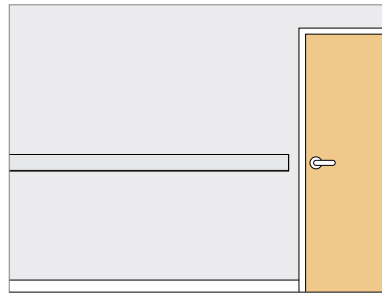

Single SSWG1 Stainless Steel Wall Guard
Offers protection and enhances design

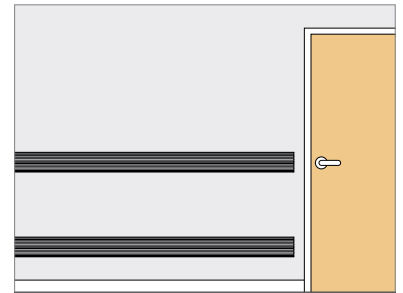

Twin WGR150E Rubber Wall Guards
Robust protection against wheeled traffic

Direct or Indirect Protection

Direct:

- Points of impact easily identifiable
- Damage is obvious and occurs in predictable patterns
- Commonly specified in existing buildings
- Suitable solution for refurbishment projects where the damaged areas are known

Indirect:

- Damage is difficult to predict
- Types and levels of traffic are unknown
- Commonly specified in new buildings
- Suitable for new build where damage is less easy to predict

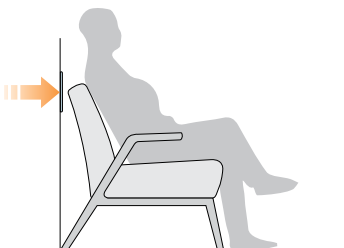

Direct Protection

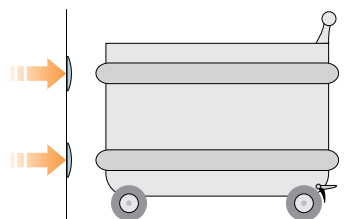

Direct Protection

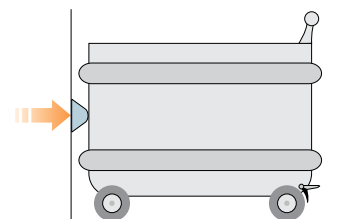

Indirect Protection

WGS200 Wall Guard

 Gradus is the largest UK manufacturer of wall protection profiles

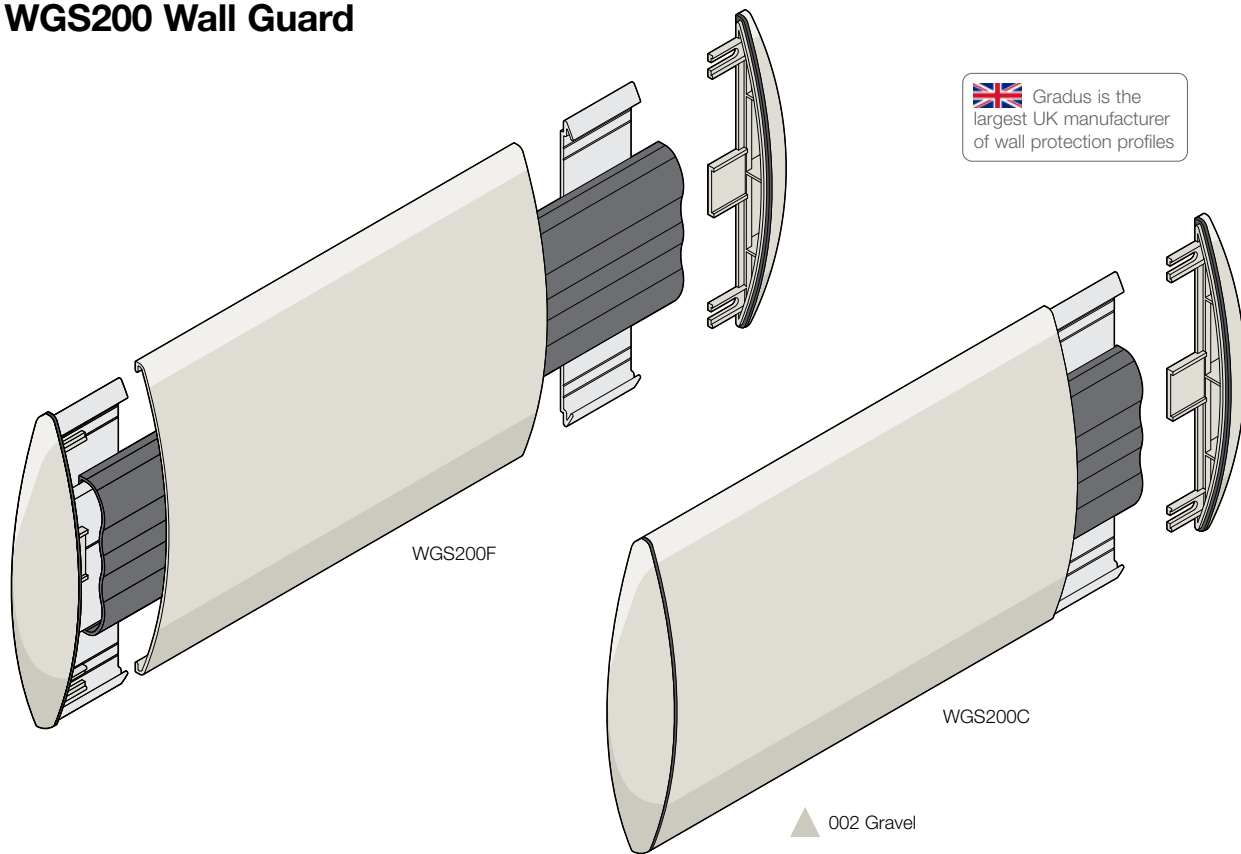

Features

Components

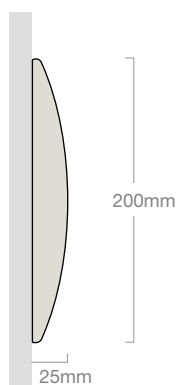

- Modular system comprising PVC-u covers, aluminium retainers and PVC-u accessories
- Replaceable, through coloured, easy-to-clean covers - textured to conceal the effects of impact and abrasion
- Features an internal bumper for additional strength and to absorb and dissipate impact
- Choice of retainers include continuous or aluminium fixing clips (see below)
- Design ensures a tight fit to wall – minimal dust/dirt trap
- Reveals provide tight, neat joints and are made from a naturally bactericidal polymer that inhibits the growth of bacteria
- Colour: Available in 33 colour options – see pages 21 - 23 for colours and availability
- Size: Supplied in 4.0m lengths
- Material: PVC-u, Aluminium
- Complementary corner guards available page 63

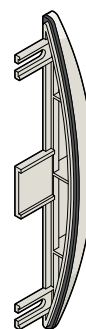

WGS2001
universal end cap
(including reveal)

Profile options

WGS200F

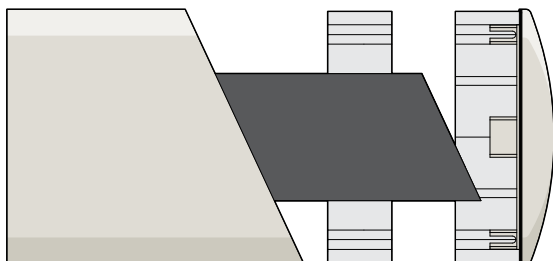

Fixing clip retainer:

- Easy to install – ideal for one person
- Cost effective solution
- Suitable for gently undulating substrates

WGS200C

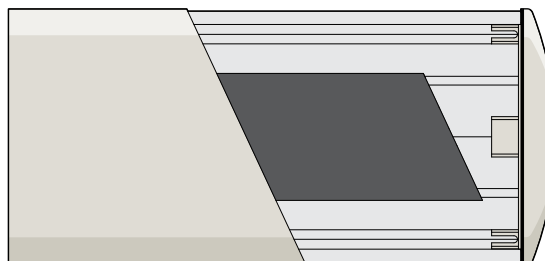

Continuous retainer:

- Provides rigid support for weaker substrates
- Ideal for bridging short gaps, recesses and voids

WGS125 Wall Guard

BIM Products available to download as BIM objects. www.gradus.com

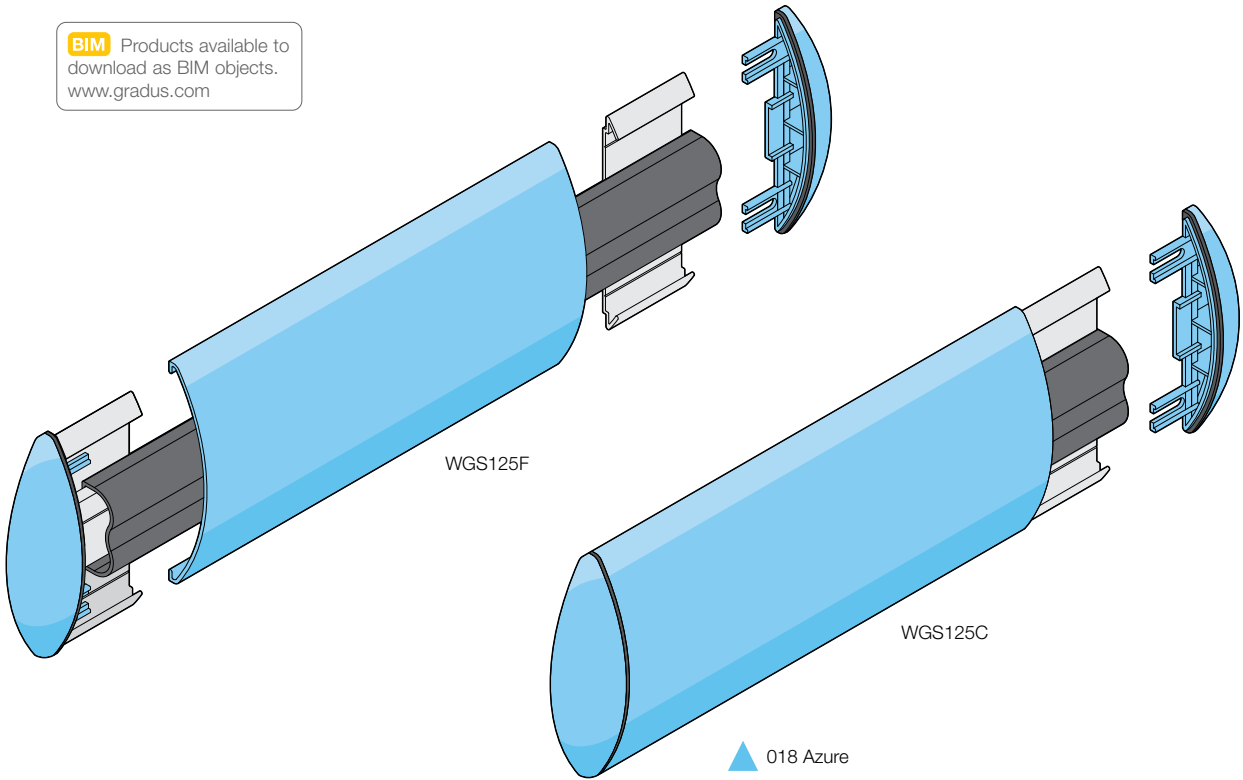

Section 2

Features

Components

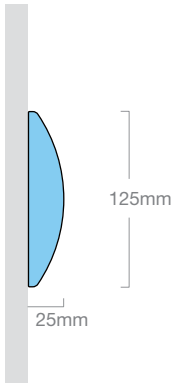

- Modular system comprising PVC-u covers, aluminium retainers and PVC-u accessories
- Replaceable, through coloured, easy-to-clean covers - textured to conceal the effects of impact and abrasion
- Features an internal bumper for additional strength and to absorb and dissipate impact
- Choice of retainers include continuous or aluminium fixing clips (see below)
- Design ensures a tight fit to wall – minimal dust/dirt trap
- Reveals provide tight, neat joints and are made from a naturally bactericidal polymer that inhibits the growth of bacteria
- Colour: Available in 32 colour options – see pages 21 - 23 for colours and availability
- Size: Supplied in 4.0m lengths
- Material: PVC-u, Aluminium
- Complementary corner guards available page 63

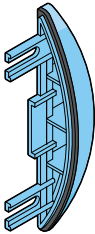

WGS1251 universal end cap (including reveal)

Profile options

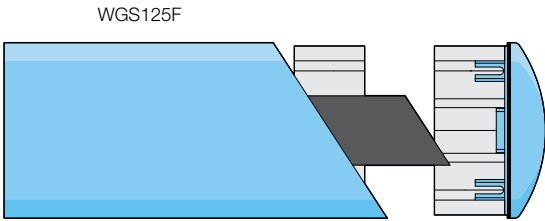

- Fixing clip retainer:**
- Easy to install – ideal for one person
 - Cost effective solution
 - Suitable for gently undulating substrates

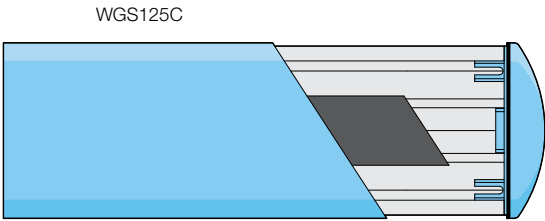

- Continuous retainer:**
- Provides rigid support for weaker substrates
 - Ideal for bridging short gaps, recesses and voids

WGA100 Wall Guard

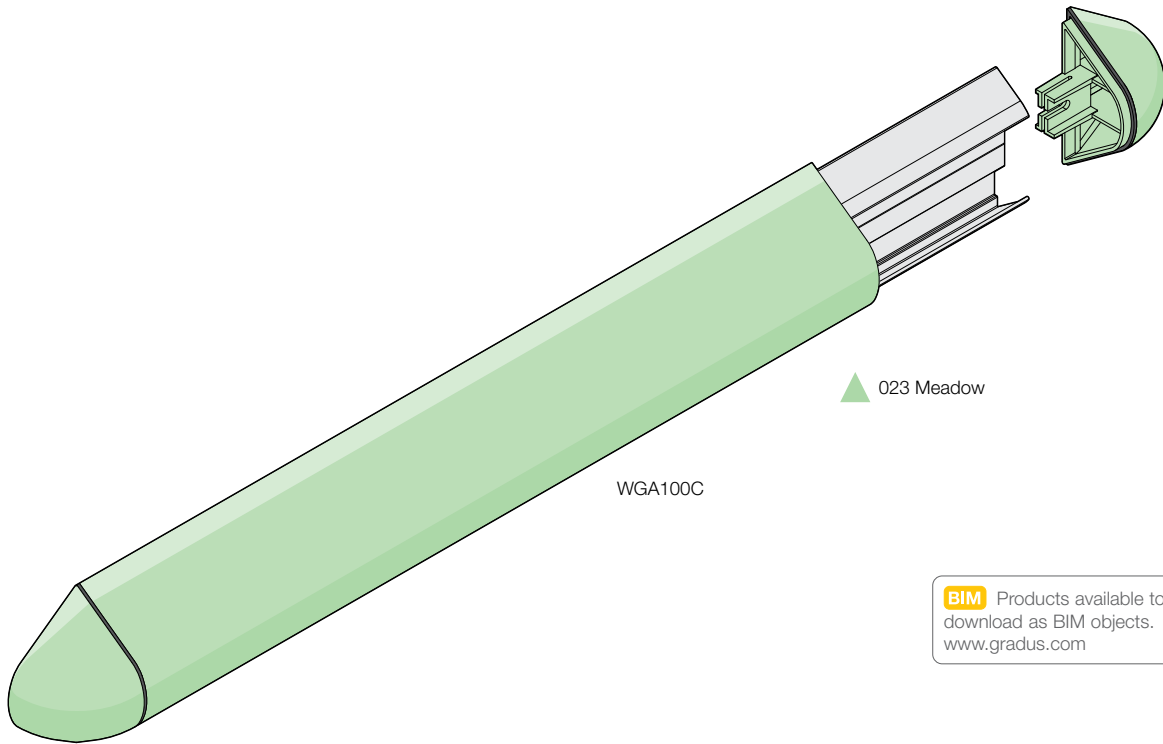

BIM Products available to download as BIM objects. www.gradus.com

Features

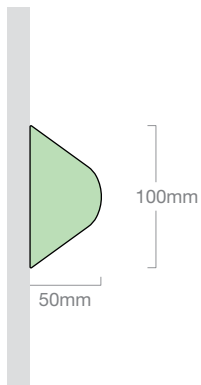

- Modular system comprising PVC-u covers, aluminium retainers and PVC-u accessories
- Replaceable, through coloured, easy-to-clean covers - textured to conceal the effects of impact and abrasion
- Angular design provides an extended depth of protection against damage
- Reveals provide tight, neat joints and are made from a naturally bactericidal polymer that inhibits the growth of bacteria
- Colour: Available in 33 colour options – see pages 21 - 23 for colours and availability
- Size: Supplied in 4.0m lengths
- Material: PVC-u, Aluminium
- Complementary corner guards available page 63

Components

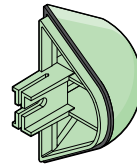

WGA1001
universal end cap
(including reveal)

Profile

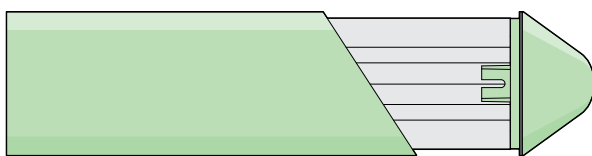

Continuous retainer provides rigid support whilst allowing the cover to flex, absorbing the effects of an impact.

WST150 & WST200 Wall Strips

 Gradus is the largest UK manufacturer of wall protection profiles

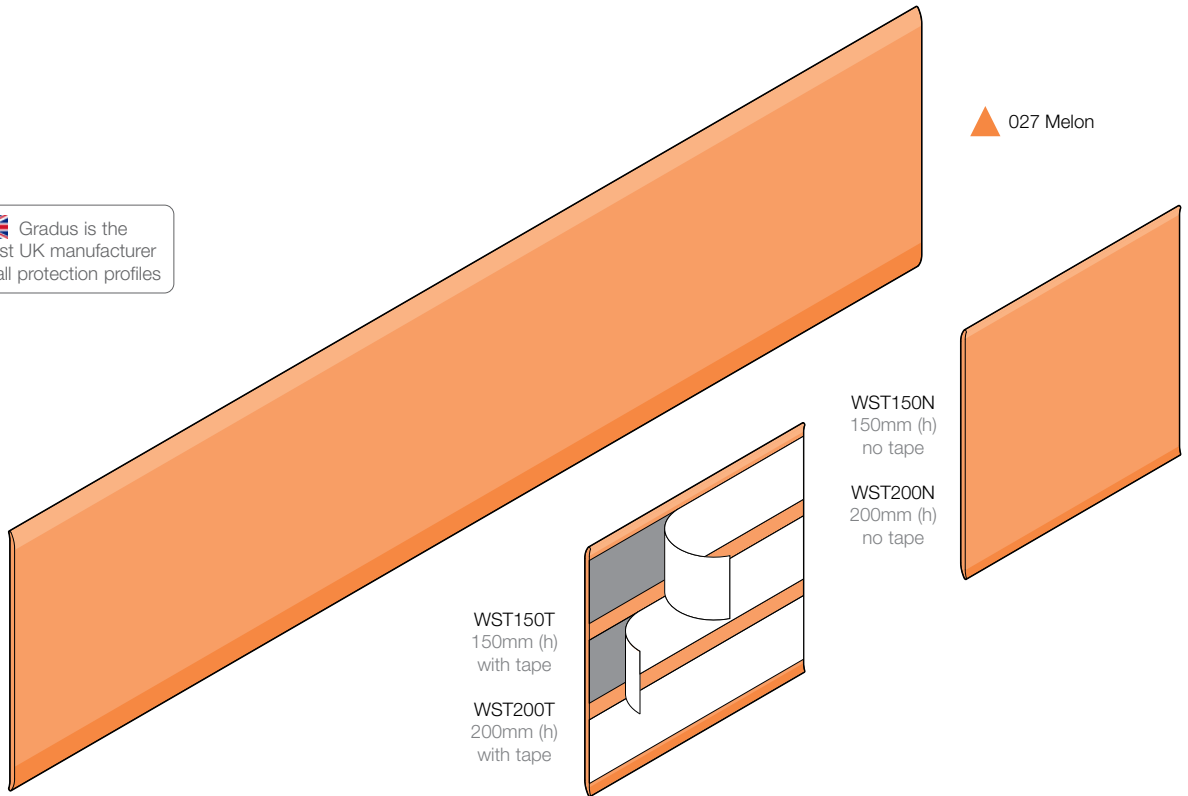

Features

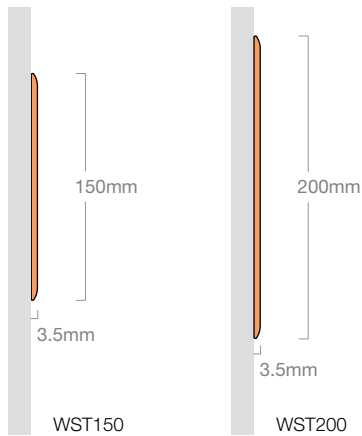

- Scratch and stain resistant PVC-u is through coloured and textured to conceal the effects of impact and abrasion
- Can be used along the entire length of a wall or cut down into kickplates or pushplates
- Ideal for protecting walls against scuffs, scratches and abrasion caused by chairs, tables, trolleys and other moveable objects
- Available with tape for quick and easy installation, or without tape for installing with a suitable adhesive
- Colour: Available in 34 colour options – see pages 21 - 23 for colour offer and availability
- Size: Supplied in 4.0m lengths
- Material: PVC-u

Profile



As an alternative SureProtect Endure® PVC-u sheet can also be cut into rubrails (see pages 27 & 30)

SSWG Stainless Steel Wall Guards

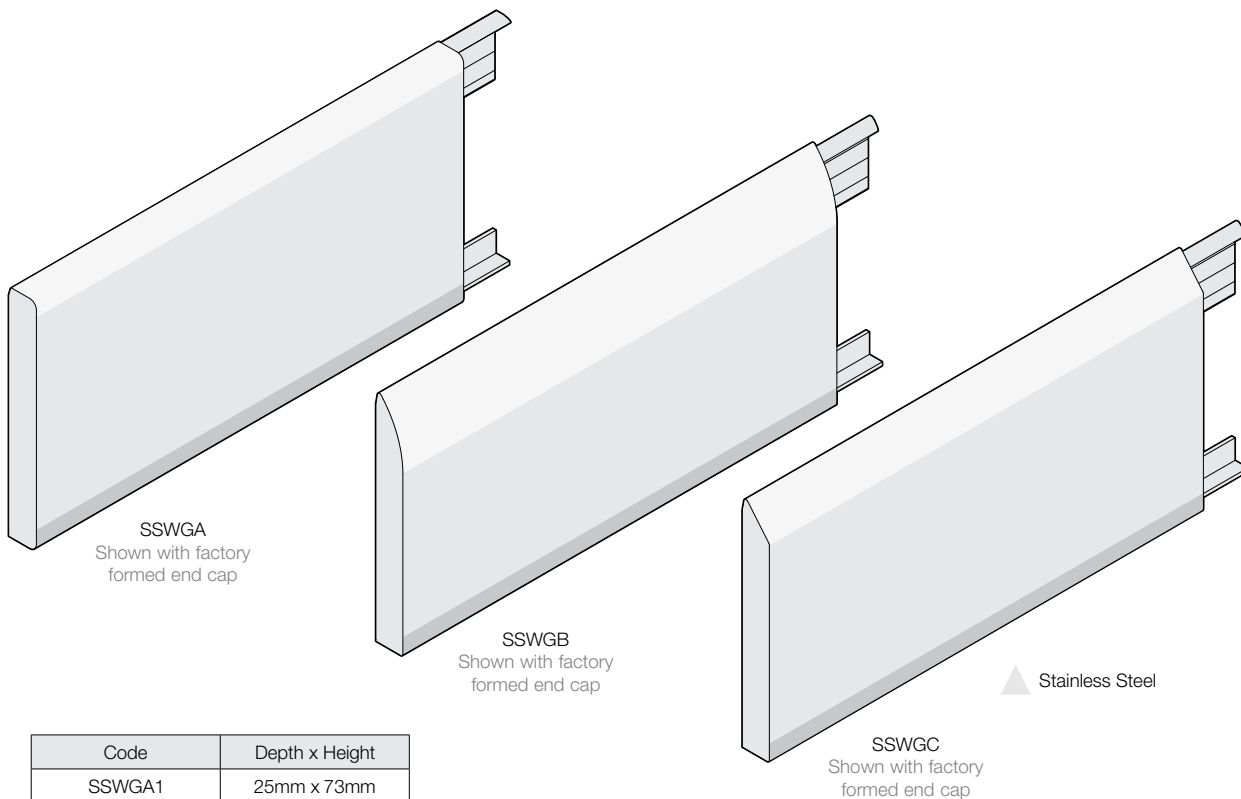

Code	Depth x Height
SSWGA1	25mm x 73mm
SSWGA2	25mm x 101mm
SSWGA3	25mm x 152mm
SSWGA4	25mm x 195mm
SSWGB1	25mm x 125mm
SSWGB2	25mm x 200mm
SSWGC1	25mm x 150mm
SSWGC2	25mm x 200mm

Features

- Continuous stainless steel covers with aluminium fixing retainers
- 3 profile designs intended for interior use
- Hygienic nature of stainless steel makes the wall guards ideal for use in environments such as food and pharmaceutical preparation and manufacturing facilities
- End caps are formed during manufacture
- Colour: Satin finish
- Size: Supplied cut to size to a maximum length of 2.95m (longer runs should be butt jointed on-site)
- Material: 304 grade stainless steel
- Complementary corner guards available page 68

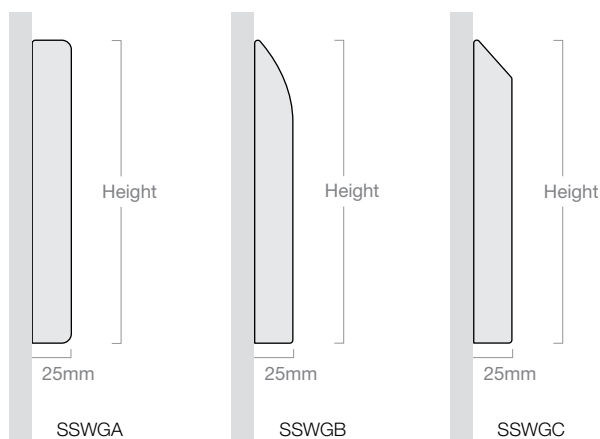

Profiles

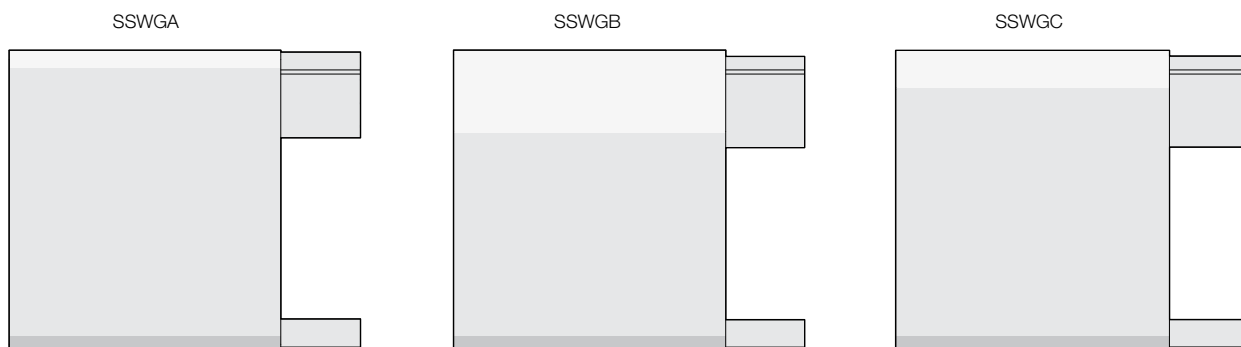

WGR Rubber Wall Guards

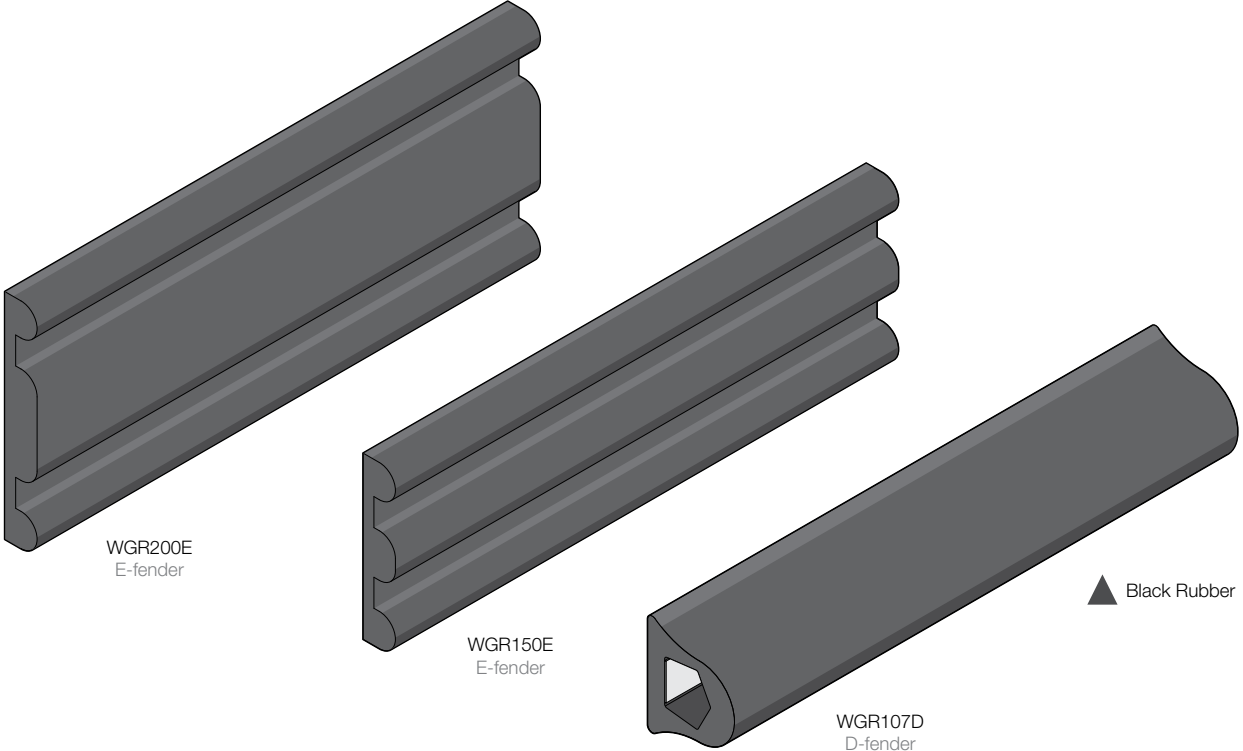

Features

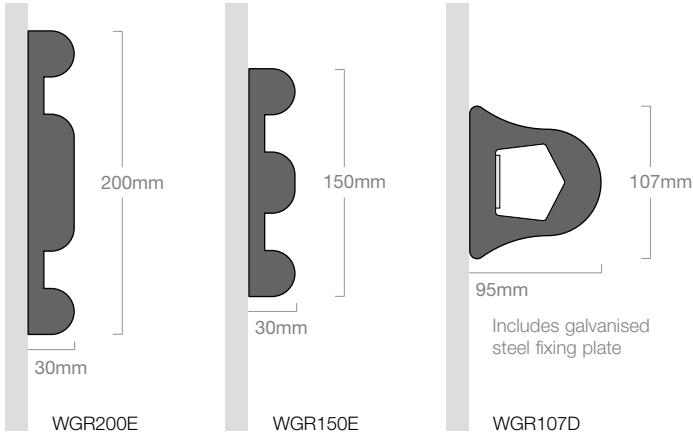

- Black rubber minimises the appearance of scuffs and scrapes
- Profiles absorb the effects of impact, minimising the extent of the damage
- Suitable for both interior & exterior environments. Can be fixed to practically any substrate, including concrete, brickwork and blockwork
- Internal and external corners are created through on-site mitring
- Ideal for use in manufacturing, warehousing and loading bays, back of house retail, hospital service corridors and car parks
- Colour: Black only
- Size: Supplied in 3.0m lengths
- Material: Rubber
- Complementary corner guards available page 69

Profiles



BHPA100 Bed Head Protectors

 Gradus is the largest UK manufacturer of wall protection profiles

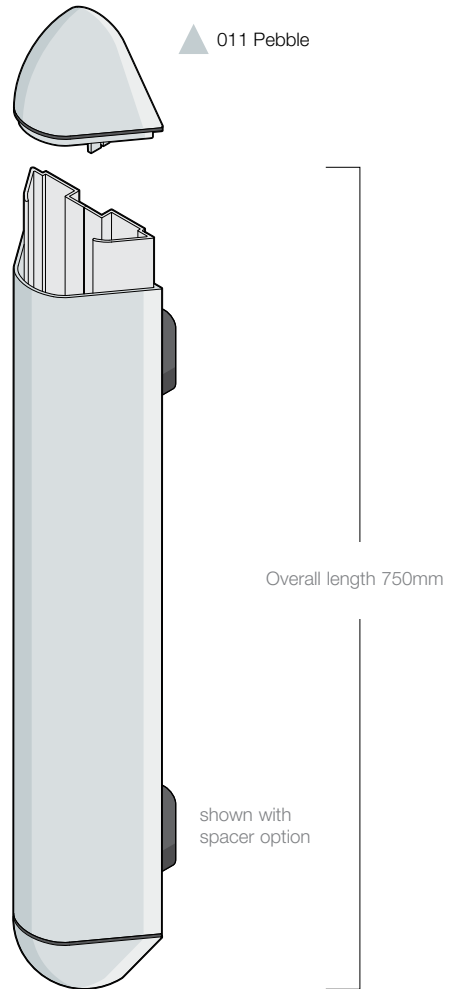
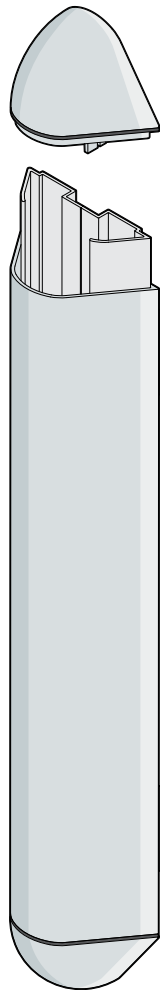

- Generally fixed vertically on to walls in pairs
- Can be used individually as chair protectors
- Supplied as a pre-cut packaged system for ease of installation
- Comprising PVC-u covers, aluminium retainers PVC-u end caps and rubber spacers
- Reveals provide tight, neat joints and are made from naturally bactericidal polymer that inhibits growth of bacteria
- 3 Extender options are available to provide increased projection allowing for protection of medical services and trunking (see page 42) – contact Gradus Technical Support for information
- Designed to prevent damage to walls and wall mounted equipment from beds that are frequently moved around, elevated or inclined
- Utilises the WGA100 wall guard (see page 42)
- Supplied as part of a kit 750mm long
- Colour: Available in 33 colour options - see pages 21 - 23 for colours and availability
- Size: Supplied in kit format - 2 units - 750mm (including end caps)
- Material: PVC-u, Aluminium

Profile _____

Features

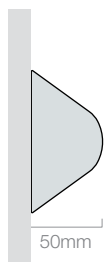

Direct fix
BHPA1001

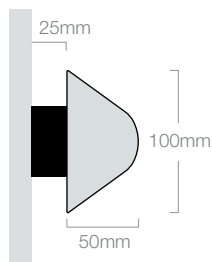

Rubber spacer
BHPA1002

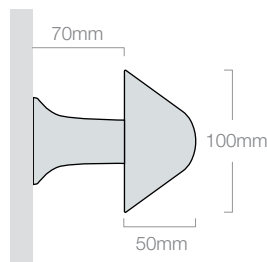

Bracket & washer
BHPA1003

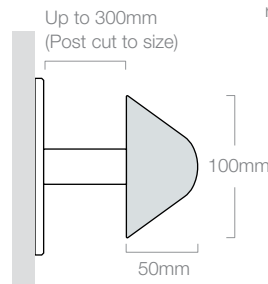

Up to 300mm
(Post cut to size)
Metal extender bracket
BHPA1004

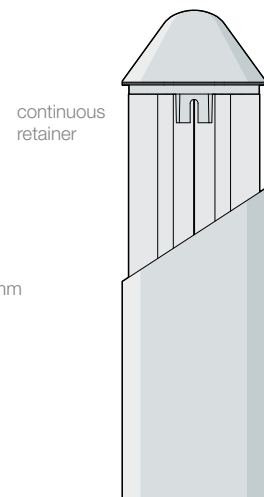

continuous
retainer

See page 48 for more information

BHPA125 Bed Head Protector

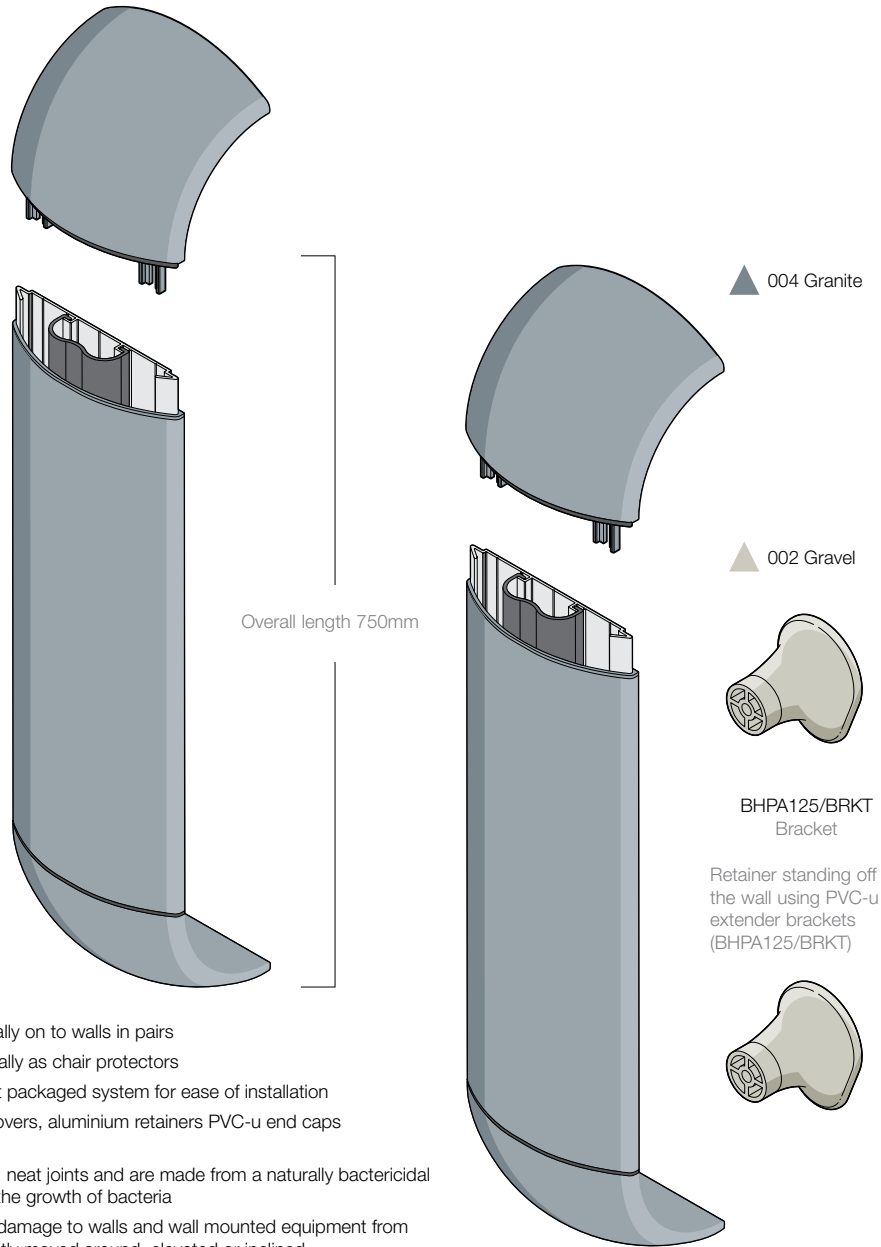

- Generally fixed vertically on to walls in pairs
- Can be used individually as chair protectors
- Supplied as a pre-cut packaged system for ease of installation
- Comprising PVC-u covers, aluminium retainers PVC-u end caps and brackets
- Reveals provide tight, neat joints and are made from a naturally bactericidal polymer that inhibits the growth of bacteria
- Designed to prevent damage to walls and wall mounted equipment from beds that are frequently moved around, elevated or inclined
- Supplied as part of a kit 750mm long
- Colour: Available in 32 colour options - see pages 21 - 23 for colours and availability
- Size: Supplied in kit format - 2 units - 750mm (including end caps)
- Material: PVC-u, Aluminium
- Utilises WGS125 (see page 41)

Profile

Features

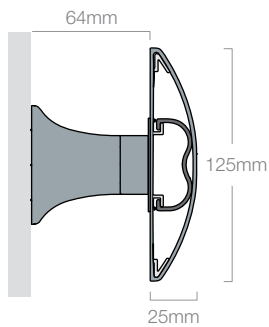

Bracket

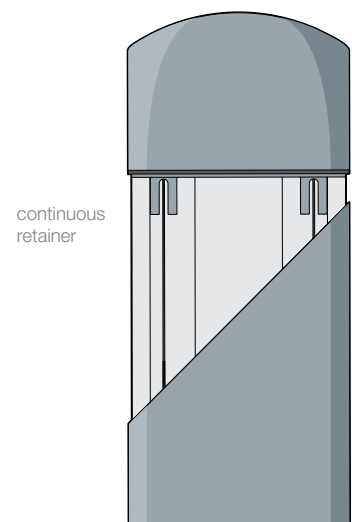

continuous retainer

BHPA100 Bed Head Protectors Options

Option 1

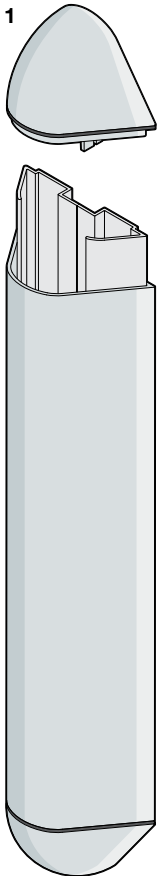

BHPA1001

▲ 011 Pebble

Aluminium retainer fixed directly to the wall

Option 2

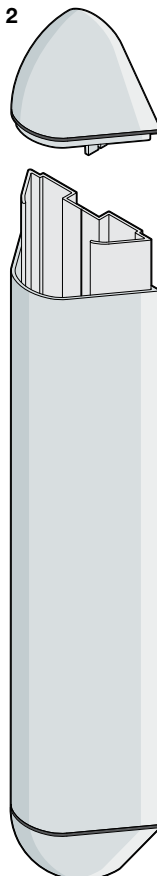

BHPA1002

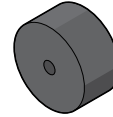

WGRS25 Spacer

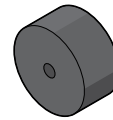

Retainer standing off the wall using rubber spacers (WGRS25)

Option 3

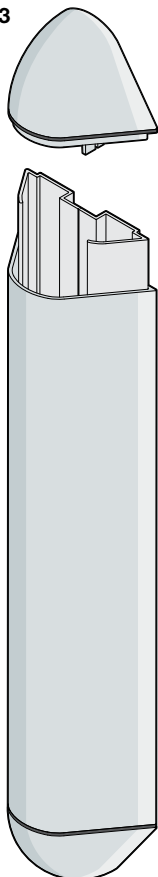

BHPA1003

▲ 002 Gravel

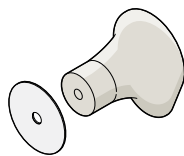

BHPA1003/BRKT Bracket

Retainer standing off the wall using PVC-u extender brackets (BHPA1003/BRKT)

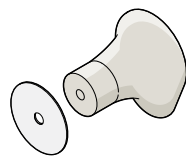

Ø50 Penny Washer

Option 4

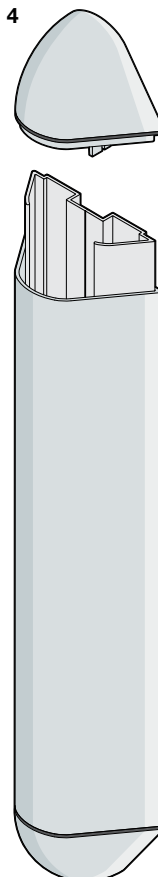

BHPA1004

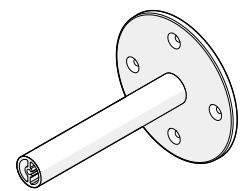

BLXB2 Extender bracket

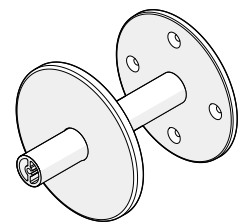

Option of a cover rose BLXBCP2



